

# EXPLORER FUEGO COLLECTION - ACCENT TABLE

## Assembly Instructions

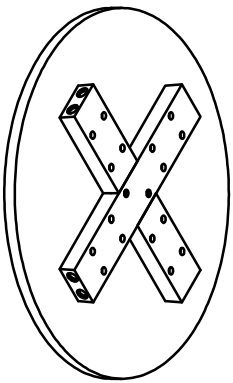

Ax1

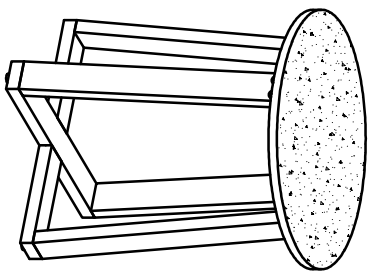
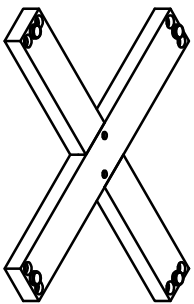

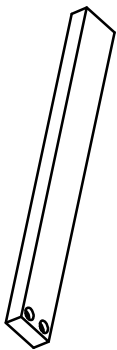

Bx1



Cx4

### LIST OF HARDWARE

NO.	HARDWARE	QTY.
1	F-BOLT 	16
2	Allenkey 	01

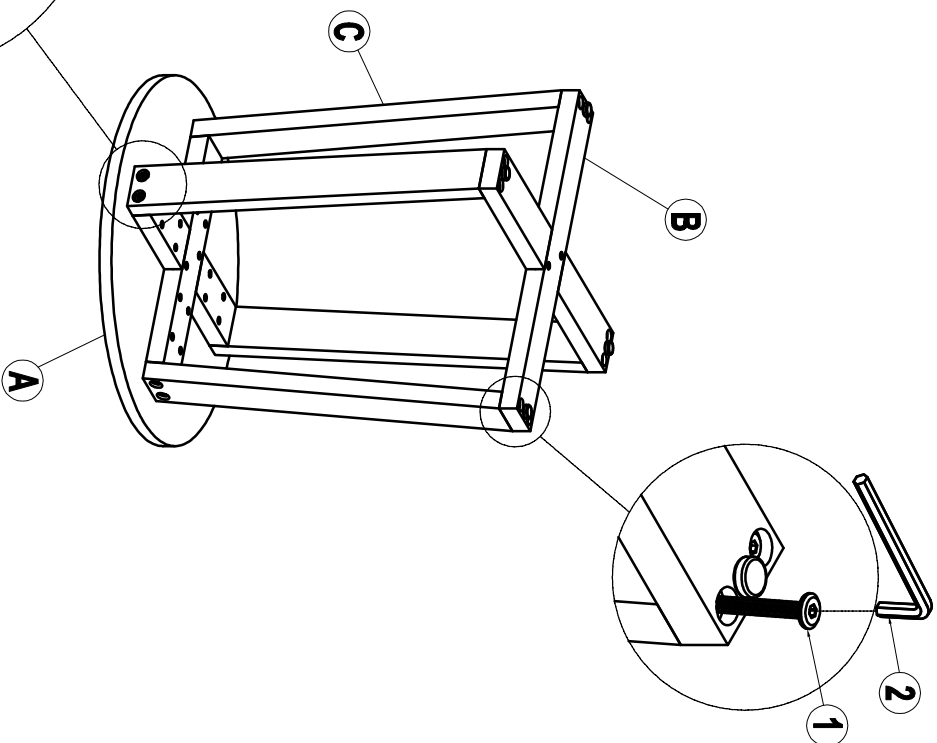

**WARNING!** DO NOT use this chair or table in any other way than it is intended. Tables are not designed or intended to be climbed on to, jumped on or stood on. All chair legs **MUST** remain on the ground surface at all times. **DO NOT** rock on back chair legs. Chairs are **ONLY** to be used for sitting on by 1 person at a time. **ALWAYS** supervise Children for safe use of furniture. **FAILURE TO FOLLOW THIS WARNING CAN LEAD TO: SEVERE BODILY INJURY, DEATH OR LOSS OF PROPERTY**