

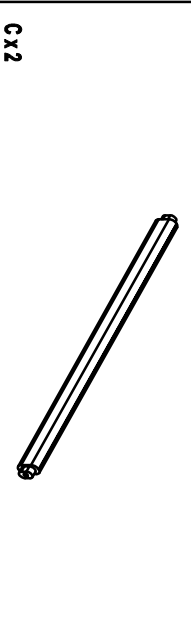

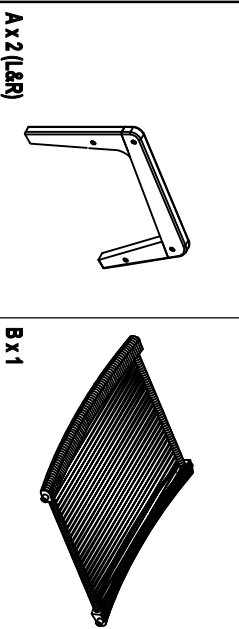

OCEANS OTTOMAN

Assembly Instructions

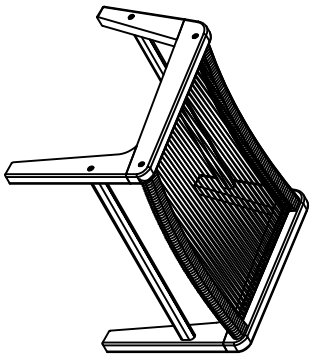

LIST OF HARDWARE		
NO.	HARDWARE	QTY.
1	F-Bolt 	8
2	Allen key 	1
3	Wood Nut 	8
4	F-Screw 	2

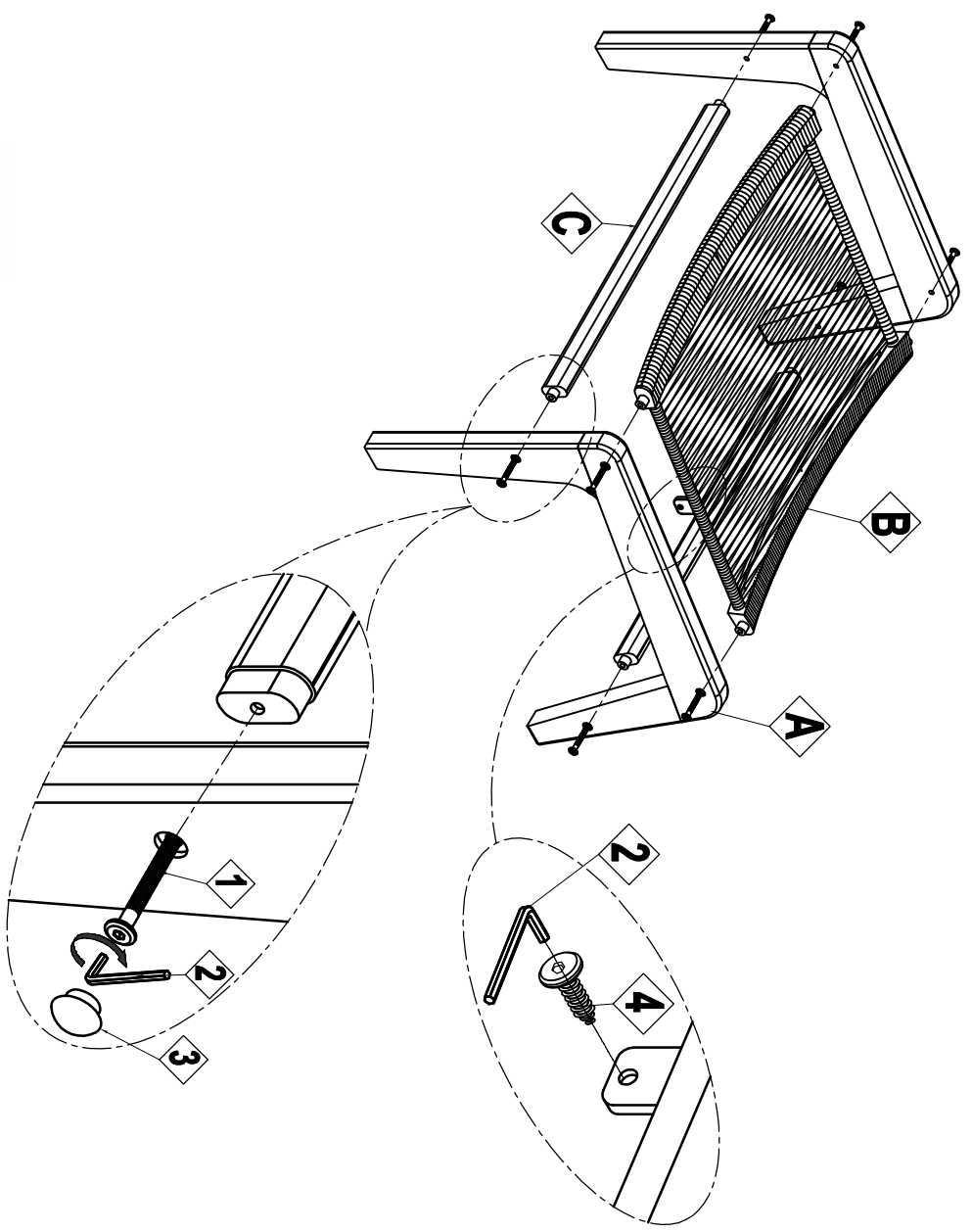

WARNING! DO NOT use this chair or table in any other way than it is intended. Tables are not designed or intended to be climbed on to, jumped on or stood on. All chair legs **MUST** remain on the ground surface at all times. **DO NOT** rock on back chair legs. Chairs are **ONLY** to be used for sitting on by 1 person at a time. **ALWAYS** supervise children for safe use of furniture. **FAILURE TO FOLLOW THIS WARNING CAN LEAD TO: SEVERE BODILY INJURY, DEATH OR LOSS OF PROPERTY**